

AC centrifugal fans - RadiCal®

Series R2E190 RA Ø190 mm



Highlights:

- Backward curved
- 7-blade impeller, single phase motor
- Thermal overload protector (TOP) wired internally
- Mounting position: Any
- Condensate discharge holes: None
- Ingress protection of IP44; dependent on installation and position

Material: Fiberglass reinforced composite
Impeller: PA

Direction of rotation: Clockwise, seen on rotor

Nominal Data	Air flow		Nominal voltage	Hertz	Ball bearings	Power input	Speed (1)	Temperature range (1)	Mass	Ingress Protection Rating	Capacitor	UL
	Type	CFM										
R2E190-RA50-21	341.4	115	50/60	Yes	70	2,450	-25...75	1,200	IP44	6	Yes	
R2E190-RA26-20	347.3	230	50/60	Yes	70	2,500	-25...75	1,200	IP44	1.5	Yes	

(1) Nominal data at operating point with maximum load.

R2E190-RA50-21 Curves

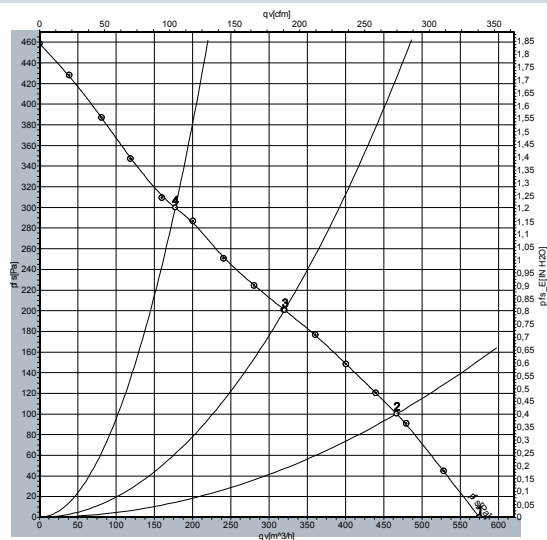

Measurement: LU-128367

Air performance measured as per: ISO 5801, Installation category A, without protection against accidental contact.

Suction-side noise levels: LwA as per ISO 13347, LPA measured at 1m distance to fan axis.

The values given are valid under the measuring conditions mentioned and may vary according to the actual installation situation.

With any deviation to the standard set-up, the specific values have to be checked and reviewed once installed or fitted.

For detailed information on the measuring set-up, please contact ebm-papst.

	n rpm	Pe W	I A (115V)	LwA dB(A)
Ⓐ 1	2750	60	0.53	68
Ⓐ 2	2575	63	0.55	64
Ⓐ 3	2450	66	0.59	60
Ⓐ 4	2630	62	0.54	65

R2E190-RA26-20 Curves

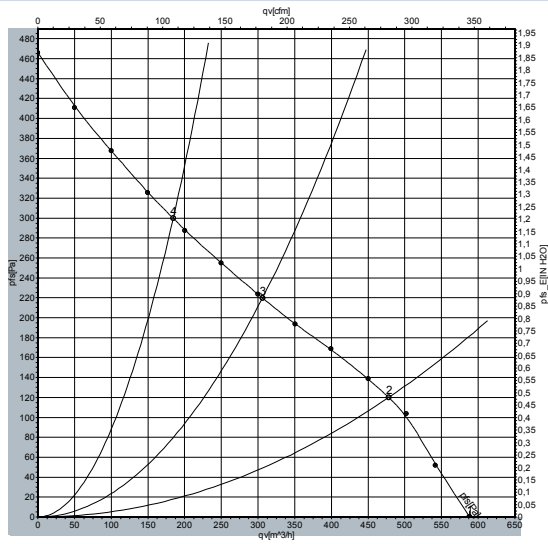

Measurement: LU-125753

Air performance measured as per: ISO 5801, Installation category A, without protection against accidental contact.

Suction-side noise levels: LWA as per ISO 13347, LPA measured at 1m distance to fan axis.

The values given are valid under the measuring conditions mentioned and may vary according to the actual installation situation.

With any deviation to the standard set-up, the specific values have to be checked and reviewed once installed or fitted.

For detailed information on the measuring set-up, please contact ebm-papst.

	n rpm	Pe W	I A (230V)	L _{WA} dB(A)
①	2720	60	0.27	68
②	2635	62	0.27	65
③	2500	65	0.29	61
④	2670	61	0.27	66

R2E190-RAXX-XX

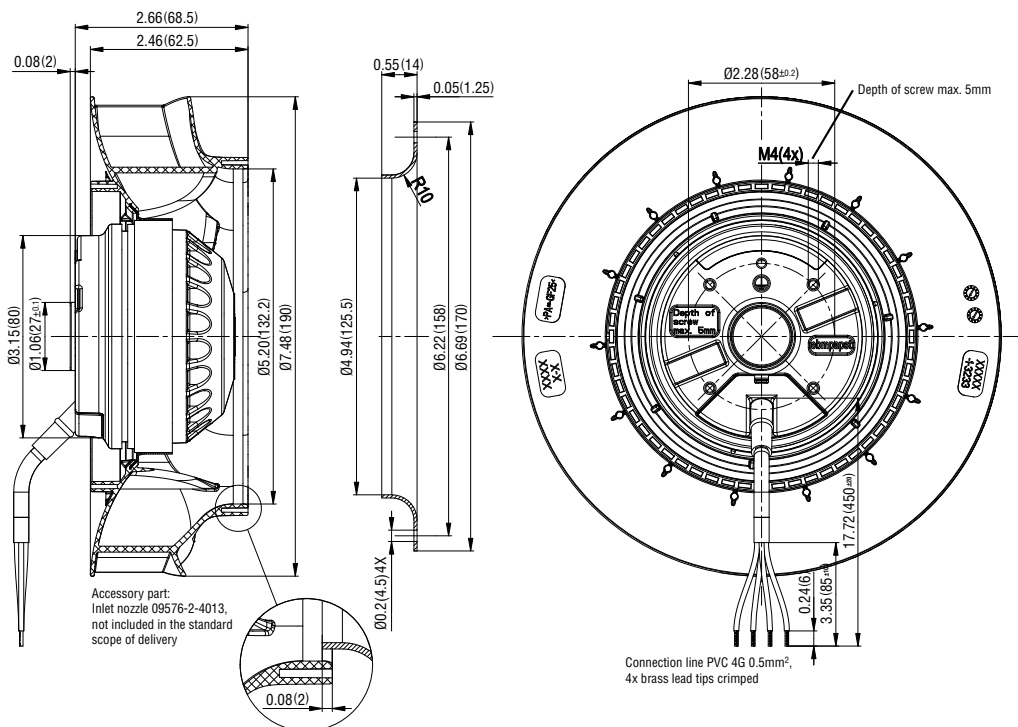

AC centrifugal fans - RadiCal®

Series R2E220 RA Ø220 mm



Highlights:

- Backward curved
- 7-blade impeller, single phase motor
- Thermal overload protector (TOP) wired internally
- Mounting position: Any
- Condensate discharge holes: None
- Ingress protection of IP44; dependent on installation and position

Material: Fiberglass reinforced composite
Impeller: PA

Direction of rotation: Clockwise, seen on rotor

Nominal Data	Air flow	Nominal voltage	Hertz	Ball bearings	Power input	Speed (1)	Temperature range (1)	Mass	Ingress Protection Rating	Capacitor	UL
	CFM	VAC			Watts	RPM	°C	g		µF	
R2E220-RA44-14	529.7	115	50/60	Yes	108	2,100	-25...60	1,300	IP44	8	Yes
R2E220-RA38-13	541.5	230	50/60	Yes	107	2,050	-25...60	1,300	IP44	2	Yes

(1) Nominal data at operating point with maximum load.

R2E220-RA44-14 Curves

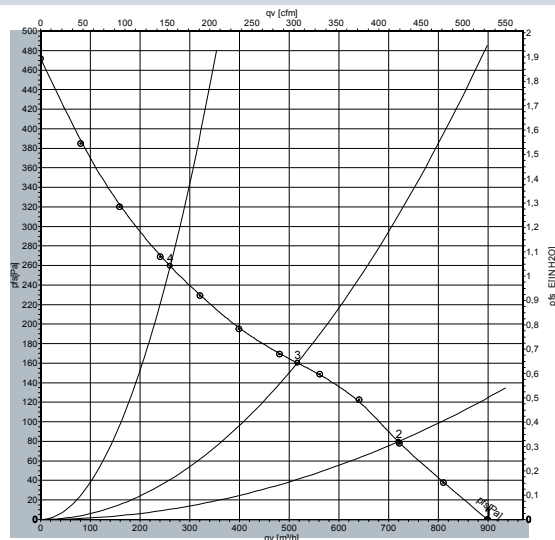

Measurement: LU-130009

Air performance measured as per: ISO 5801, Installation category A, without protection against accidental contact.

Suction-side noise levels: LwA as per ISO 13347, LpA measured at 1m distance to fan axis.

The values given are valid under the measuring conditions mentioned and may vary according to the actual installation situation.

With any deviation to the standard set-up, the specific values have to be checked and reviewed once installed or fitted.

For detailed information on the measuring set-up, please contact ebm-papst.

	n rpm	Pe W	I A (115V)	LwA dB(A)
Ⓐ 1	2455	92	0.81	69
Ⓐ 2	2260	98	0.85	62
Ⓐ 3	2100	100	0.88	60
Ⓐ 4	2265	96	0.84	65

R2E220-RA38-13 Curves

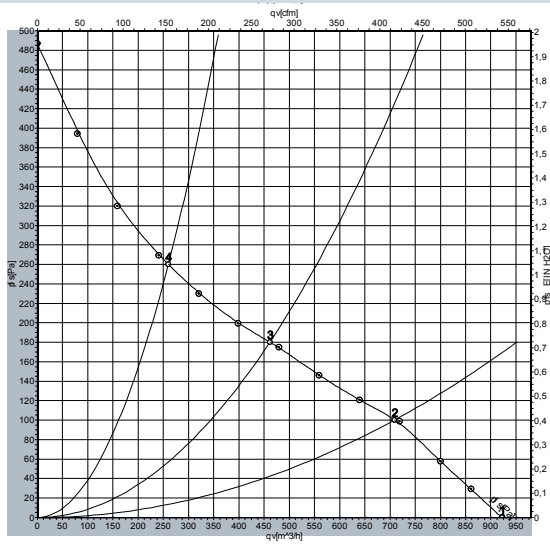

Measurement: LU-136805

Air performance measured as per: ISO 5801, Installation category A, without protection against accidental contact.

Suction-side noise levels: L_{WA} as per ISO 13347, L_{PA} measured at 1m distance to fan axis.

The values given are valid under the measuring conditions mentioned and may vary according to the actual installation situation.

With any deviation to the standard set-up, the specific values have to be checked and reviewed once installed or fitted.

For detailed information on the measuring set-up, please contact ebm-papst.

	n	Pe	I	L _{WA}
	rpm	W	A	dB(A)
			(230V)	
ⓑ 1	2450	102	0.46	69
ⓑ 2	2220	106	0.46	62
ⓑ 3	2050	107	0.47	60
ⓑ 4	2215	105	0.46	65

R2E220-RAXX-XX

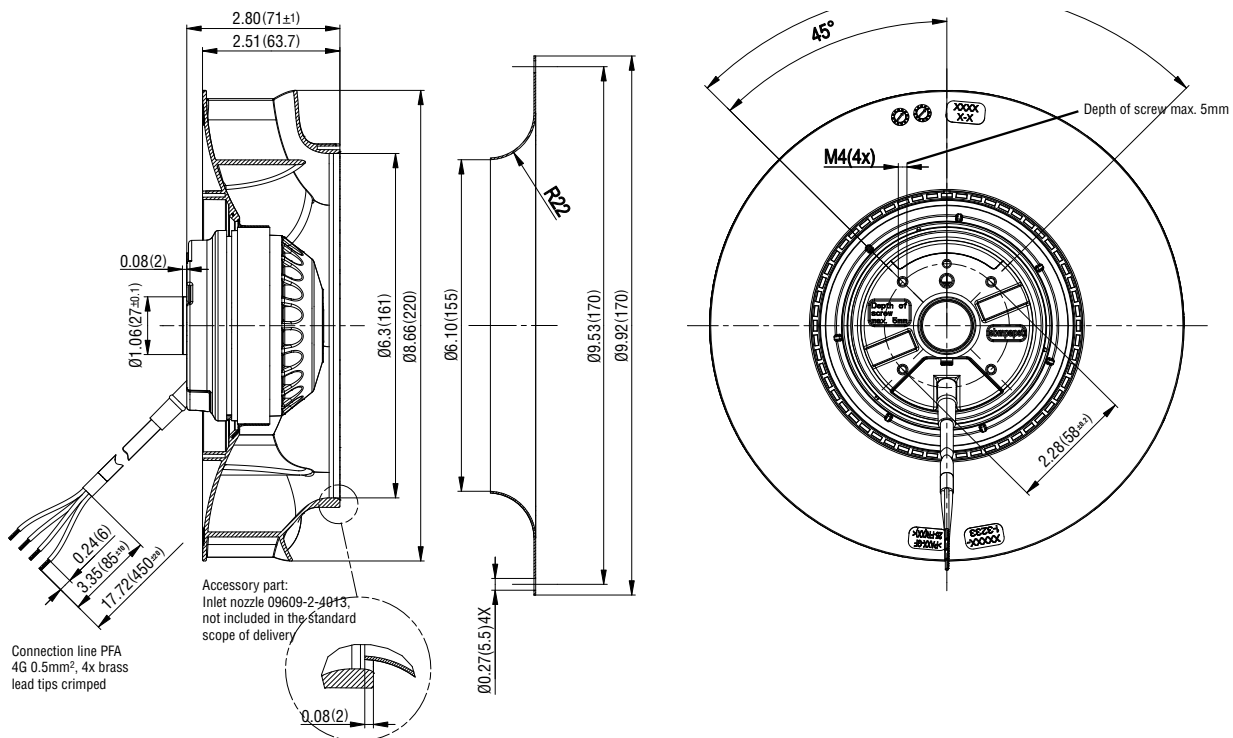

AC centrifugal fans - RadiCal®

Series R2E225 RA Ø225 mm



Highlights:

- Backward curved
- 7-blade impeller, single phase motor
- Thermal overload protector (TOP) wired internally
- Mounting position: Any
- Condensate discharge holes: None
- Ingress protection of IP44; dependent on installation and position

Material: Fiberglass reinforced composite
Impeller: PA

Direction of rotation: Clockwise, seen on rotor

Nominal Data	Air flow	Nominal voltage	Hertz	Ball bearings	Power input	Speed (1)	Temperature range (1)	Mass	Ingress Protection Rating	Capacitor	UL
	CFM	VAC			Watts	RPM	°C	g		µF	
R2E225-RA40-21	788.7	115	50/60	Yes	225	2,700	-25...40	2,300	IP44	14	Yes
R2E225-RA92-20	765.2	230	50/60	Yes	225	2,600	-25...45	2,300	IP44	3.5	Yes

(1) Nominal data at operating point with maximum load.

R2E225-RA40-21 Curves

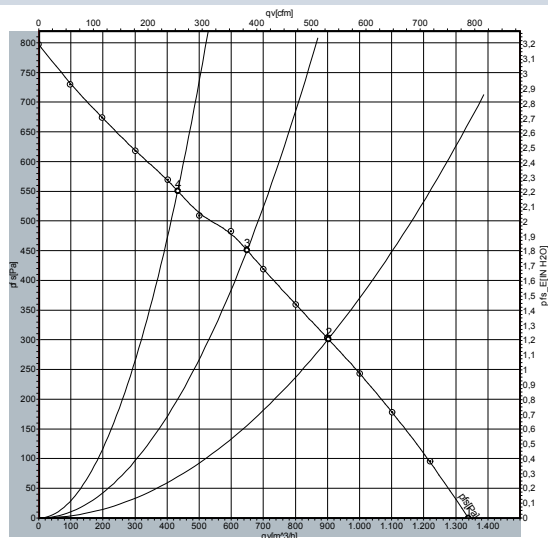

Measurement: LU-128357

Air performance measured as per: ISO 5801, Installation category A, without protection against accidental contact.

Suction-side noise levels: LwA as per ISO 13347, LpA measured at 1m distance to fan axis.

The values given are valid under the measuring conditions mentioned and may vary according to the actual installation situation.

With any deviation to the standard set-up, the specific values have to be checked and reviewed once installed or fitted.

For detailed information on the measuring set-up, please contact ebm-papst.

	n	Pe	I	LwA
	rpm	W	A (115V)	dB(A)
Ⓐ 1	3025	187	1.61	76
Ⓐ 2	2700	225	1.95	70
Ⓐ 3	2765	218	1.89	69
Ⓐ 4	2890	204	1.76	71

R2E225-RA92-20 Curves

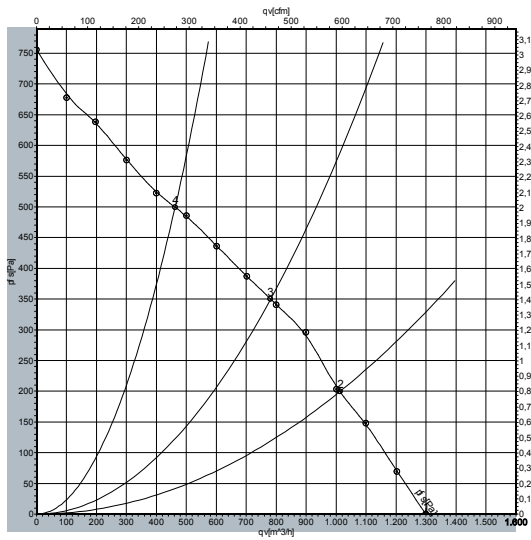

Measurement: LU-127148

Air performance measured as per: ISO 5801, Installation category A, without protection against accidental contact.

Suction-side noise levels: L_{WA} as per ISO 13347, L_{PA} measured at 1m distance to fan axis.

The values given are valid under the measuring conditions mentioned and may vary according to the actual installation situation.

With any deviation to the standard set-up, the specific values have to be checked and reviewed once installed or fitted.

For detailed information on the measuring set-up, please contact ebm-papst.

	n rpm	P _e W	I A (230V)	L _{WA} dB(A)
ⓑ 1	2900	190	0.83	76
ⓑ 2	2700	210	0.92	72
ⓑ 3	2700	207	0.90	68
ⓑ 4	2815	196	0.85	73

R2E225-RAXX-XX

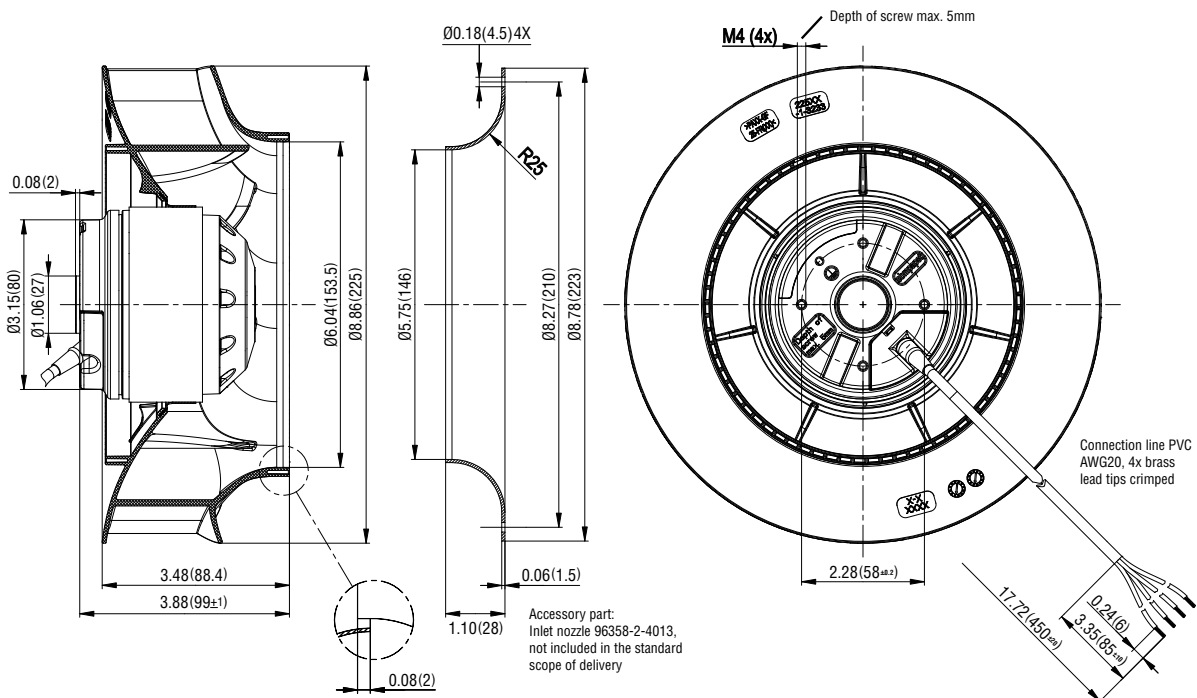

AC centrifugal fans - RadiCal®

Series R2E250 RB Ø250 mm



Highlights:

- Backward curved
- 7-blade impeller, single phase motor
- Thermal overload protector (TOP) wired internally
- Mounting position: Shaft horizontal or rotor on bottom; rotor on top on request
- Condensate discharge holes: Rotor-side
- Ingress protection of IP44; dependent on installation and position

Material: Fiberglass reinforced composite
Impeller: PA

Direction of rotation: Clockwise, seen on rotor

Nominal Data	Air flow	Nominal voltage	Hertz	Ball bearings	Power input	Speed (1)	Temperature range (1)	Mass	Ingress Protection Rating	Capacitor	UL
	CFM	VAC			Watts	RPM	°C	g		µF	
R2E250-RB02-11	1010.1	115	50/60	Yes	395	3,050	-25...60	3,800	IP44	20	Yes
R2E250-RB06-12	1006.5	230	50/60	Yes	390	3,100	-25...55	3,800	IP44	5	Yes

(1) Nominal data at operating point with maximum load.

R2E250-RB02-11 Curves

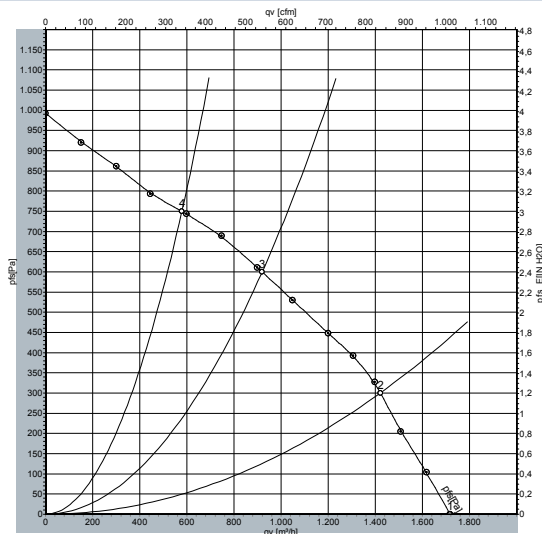

Measurement: LU-131705

Air performance measured as per: ISO 5801, Installation category A, without protection against accidental contact.

Suction-side noise levels: LWA as per ISO 13347, LPA measured at 1m distance to fan axis.

The values given are valid under the measuring conditions mentioned and may vary according to the actual installation situation.

With any deviation to the standard set-up, the specific values have to be checked and reviewed once installed or fitted.

For detailed information on the measuring set-up, please contact ebm-papst.

	n rpm	Pe W	I A (115V)	LwA dB(A)
(A) 1	3220	352	3.07	81
(A) 2	3125	380	3.31	76
(A) 3	3050	395	3.45	74
(A) 4	3170	363	3.17	80

R2E250-RB06-12 Curves

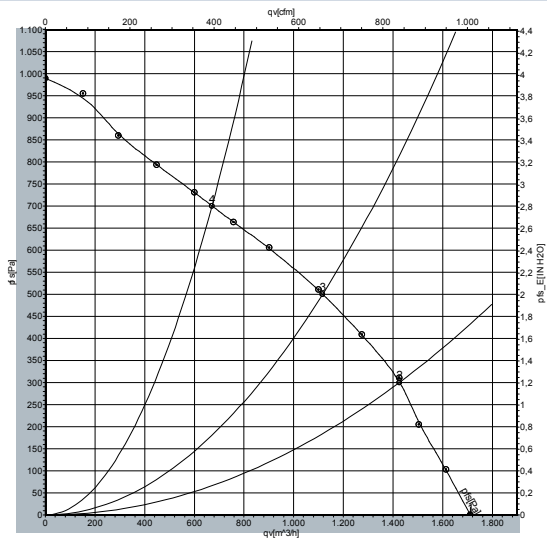

Measurement: LU-130856

Air performance measured as per: ISO 5801, Installation category A, without protection against accidental contact.

Suction-side noise levels: L_{WA} as per ISO 13347, L_{PA} measured at 1m distance to fan axis.

The values given are valid under the measuring conditions mentioned and may vary according to the actual installation situation.

With any deviation to the standard set-up, the specific values have to be checked and reviewed once installed or fitted.

For detailed information on the measuring set-up, please contact ebm-papst.

	n rpm	Pe W	I A (230V)	L _{WA} dB(A)
ⓑ 1	3200	345	1.51	81
ⓑ 2	3155	364	1.59	76
ⓑ 3	3100	390	1.71	73
ⓑ 4	3150	365	1.59	80

R2E250-RBXX-XX

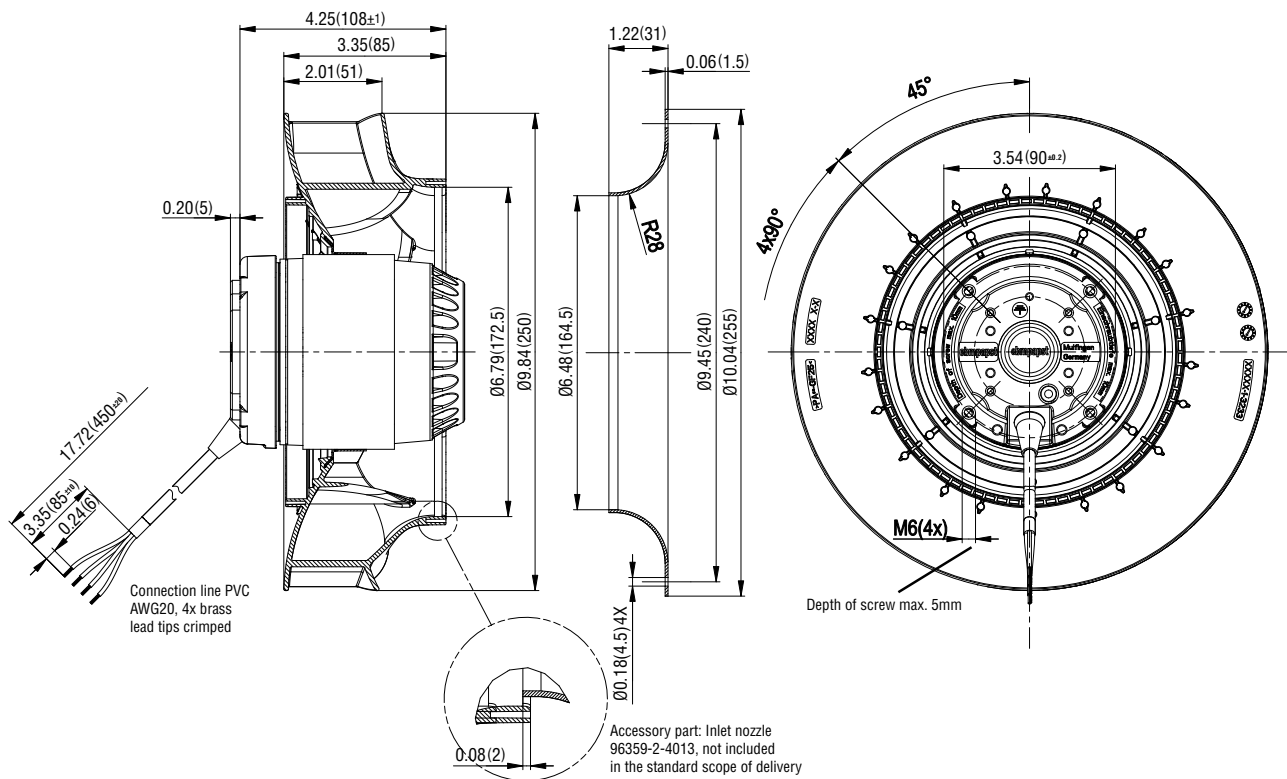

EC centrifugal fans - RadiCal®

Series R3G190 RD Ø190 mm



Highlights:

- Backward curved
- 7-blade impeller, single phase motor
- Output 10 VDC, max. 1.1 mA, Tach output, Control input 0-10 VDC / PWM
- Motor current limit, Soft start, Locked-rotor protection
- Over temperature protected electronics / motor
- Mounting position: Shaft horizontal or rotor on bottom; rotor on top on request
- Condensate discharge holes: None, open rotor
- Ingress protection of IP54

Material: Fiberglass reinforced composite
Impeller: PA6

Direction of rotation: Clockwise, seen on rotor

Nominal Data	Air flow	Nominal voltage	Voltage range	Hertz	Ball bearings	Power input	Speed (1)	Temperature range (1)	Mass	Ingress Protection Rating	UL
	CFM	VAC	VAC			Watts	RPM	°C	g		
R3G190-RD47-04	553.3	115	100...130	50/60	Yes	170	4,180	-25...50	1,400	IP54	Yes
R3G190-RD45-03	573.9	230	200...240	50/60	Yes	169	4,120	-25...60	1,380	IP54	Yes

(1) Nominal data at operating point with maximum load.

R3G190-RD47-04 Curves

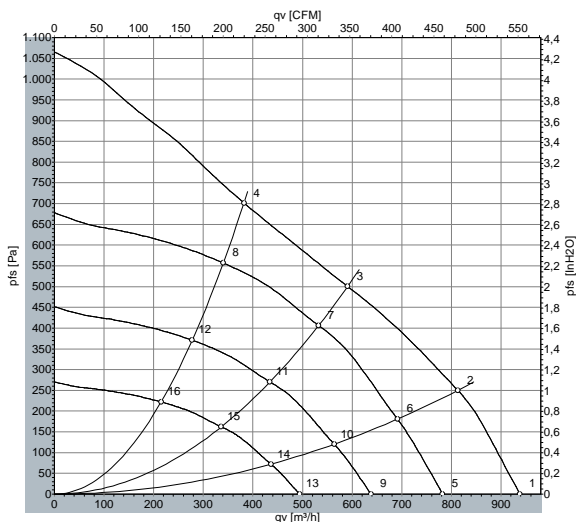

Measurement: LU-132500

Air performance measured as per: ISO 5801, Installation category A, without protection against accidental contact.

Suction-side noise levels: L_{WA} as per ISO 13347, LPA measured at 1m distance to fan axis.

The values given are valid under the measuring conditions mentioned and may vary according to the actual installation situation.

With any deviation to the standard set-up, the specific values have to be checked and reviewed once installed or fitted.

For detailed information on the measuring set-up, please contact ebm-papst.

	n rpm	Pe W	I A (115V)	L _{WA} dB(A)
(A) 1	4440	161	2.30	81
(A) 2	4235	165	2.18	75
(A) 3	4120	169	2.25	72
(A) 4	4150	160	2.17	74
(A) 5	3700	93	1.24	77
(A) 6	3700	110	1.34	72
(A) 7	3700	125	1.62	70
(A) 8	3700	114	1.54	72
(A) 9	3000	50	0.67	73
(A) 10	3000	59	0.73	68
(A) 11	3000	67	0.88	65
(A) 12	3000	61	0.84	67
(A) 13	2300	22	0.31	67
(A) 14	2300	26	0.34	62
(A) 15	2300	30	0.41	59
(A) 16	2300	27	0.39	61

R3G190-RD45-03 Curves

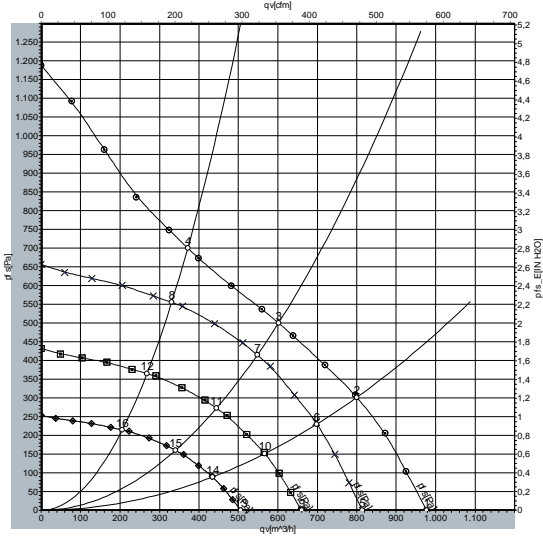

Measurement: LU-142350

Air performance measured as per: ISO 5801, Installation category A, without protection against accidental contact.

Suction-side noise levels: L_{WA} as per ISO 13347, L_{pA} measured at 1m distance to fan axis.

The values given are valid under the measuring conditions mentioned and may vary according to the actual installation situation.

With any deviation to the standard set-up, the specific values have to be checked and reviewed once installed or fitted.

For detailed information on the measuring set-up, please contact ebm-papst.

	n	Pe	I	L _{WA}
	rpm	W	A	dB(A)
			(230V)	
Ⓑ 1	4555	161	1.35	81
Ⓑ 2	4470	170	1.35	75
Ⓑ 3	4180	170	1.35	72
Ⓑ 4	4260	170	1.35	74
Ⓑ 5	3800	96	0.81	77
Ⓑ 6	3800	105	0.93	72
Ⓑ 7	3800	127	1.06	71
Ⓑ 8	3800	120	0.97	72
Ⓑ 9	3100	52	0.43	73
Ⓑ 10	3100	57	0.50	68
Ⓑ 11	3100	69	0.57	65
Ⓑ 12	3100	65	0.52	67
Ⓑ 13	2400	24	0.19	67
Ⓑ 14	2400	26	0.22	62
Ⓑ 15	2400	32	0.26	59
Ⓑ 16	2400	30	0.23	61

R3G190-RDXX-XX

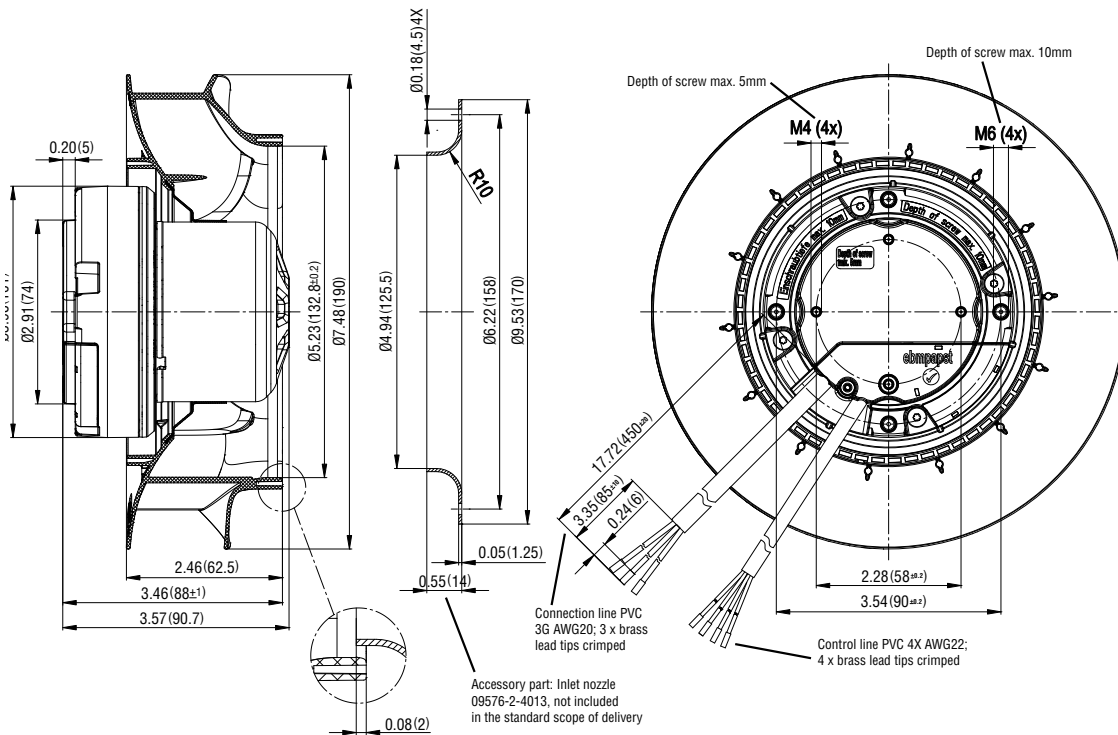

EC centrifugal fans - RadiCal®

Series R3G220 RD Ø220 mm



Highlights:

- Backward curved
- 7-blade impeller, single phase motor
- Output 10 VDC, max. 1.1 mA, Tach output, Control input 0-10 VDC / PWM
- Motor current limit, Soft start, Locked-rotor protection, Over temperature protected electronics / motor
- Mounting position: Any
- Condensate discharge holes: None, open rotor
- Ingress protection of IP54

Material: Fiberglass reinforced composite
Impeller: PA

Direction of rotation: Clockwise, seen on rotor

Nominal Data	Air flow	Nominal voltage	Voltage range	Hertz	Ball bearings	Power input	Speed (1)	Temperature range (1)	Mass	Ingress Protection Rating	UL
	CFM	VAC	VAC			Watts	RPM	°C	g		
R3G220-RD49-04	771.0	115	100...130	50/60	Yes	170	3,290	-25...50	1,500	IP54	Yes
R3G220-RD53-03	747.5	230	200...240	50/60	Yes	168	3,230	-25...45	1,450	IP54	Yes

(1) Nominal data at operating point with maximum load.

R3G220-RD49-04 Curves

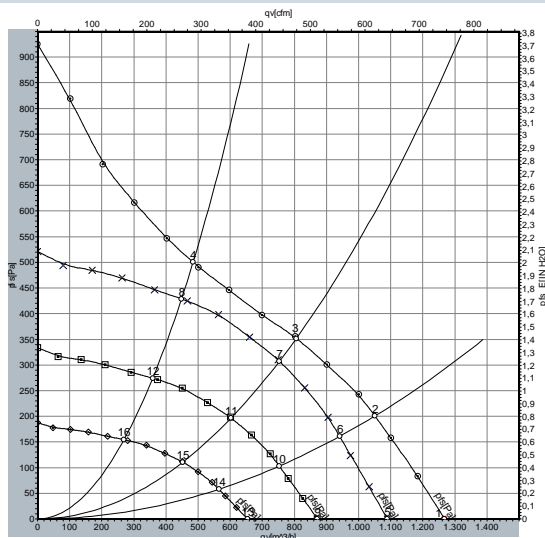

Measurement: LU-142152

Air performance measured as per: ISO 5801, Installation category A, without protection against accidental contact.

Suction-side noise levels: LwA as per ISO 13347, LPA measured at 1m distance to fan axis.

The values given are valid under the measuring conditions mentioned and may vary according to the actual installation situation.

With any deviation to the standard set-up, the specific values have to be checked and reviewed once installed or fitted.

For detailed information on the measuring set-up, please contact ebm-papst.

	n rpm	Pe W	I A (115V)	LwA dB(A)
(A) 1	3620	170	2.40	77
(A) 2	3470	170	2.40	73
(A) 3	3290	170	2.40	70
(A) 4	3355	170	2.40	72
(A) 5	3000	97	1.24	74
(A) 6	3000	112	1.43	70
(A) 7	3000	130	1.66	68
(A) 8	3000	120	1.55	70
(A) 9	2400	49	0.63	69
(A) 10	2400	57	0.73	66
(A) 11	2400	67	0.85	64
(A) 12	2400	62	0.79	66
(A) 13	1800	21	0.27	62
(A) 14	1800	24	0.31	59
(A) 15	1800	28	0.36	57
(A) 16	1800	26	0.34	59

R3G220-RD53-03 Curves

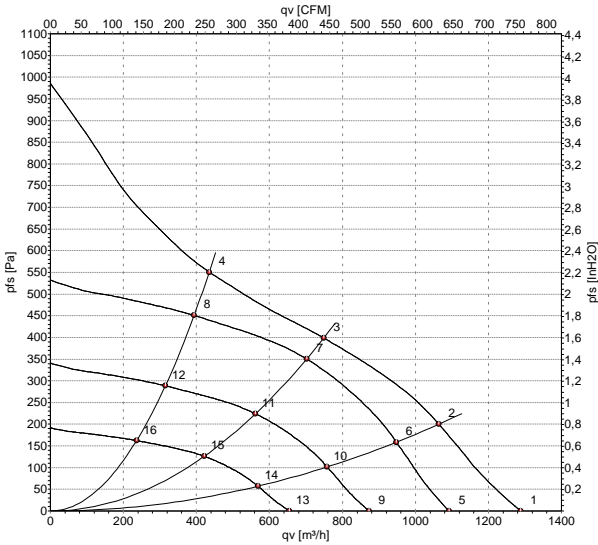

Measurement: LU-132488

Air performance measured as per: ISO 5801, Installation category A, without protection against accidental contact.

Suction-side noise levels: LWA as per ISO 13347, LPA measured at 1m distance to fan axis.

The values given are valid under the measuring conditions mentioned and may vary according to the actual installation situation.

With any deviation to the standard set-up, the specific values have to be checked and reviewed once installed or fitted.

For detailed information on the measuring set-up, please contact ebm-papst.

	n	Pe	I	LwA
	rpm	W	A (230V)	dB(A)
ⓑ 1	3540	168	1.40	78
ⓑ 2	3370	168	1.40	73
ⓑ 3	3230	168	1.40	70
ⓑ 4	3310	168	1.40	74
ⓑ 5	3000	99	0.82	73
ⓑ 6	3000	115	0.96	70
ⓑ 7	3000	135	1.12	68
ⓑ 8	3000	121	1.01	70
ⓑ 9	2400	51	0.42	68
ⓑ 10	2400	59	0.49	64
ⓑ 11	2400	69	0.57	63
ⓑ 12	2400	62	0.51	65
ⓑ 13	1800	21	0.18	61
ⓑ 14	1800	25	0.21	57
ⓑ 15	1800	29	0.24	55
ⓑ 16	1800	26	0.22	58

R3G220-RDXX-XX

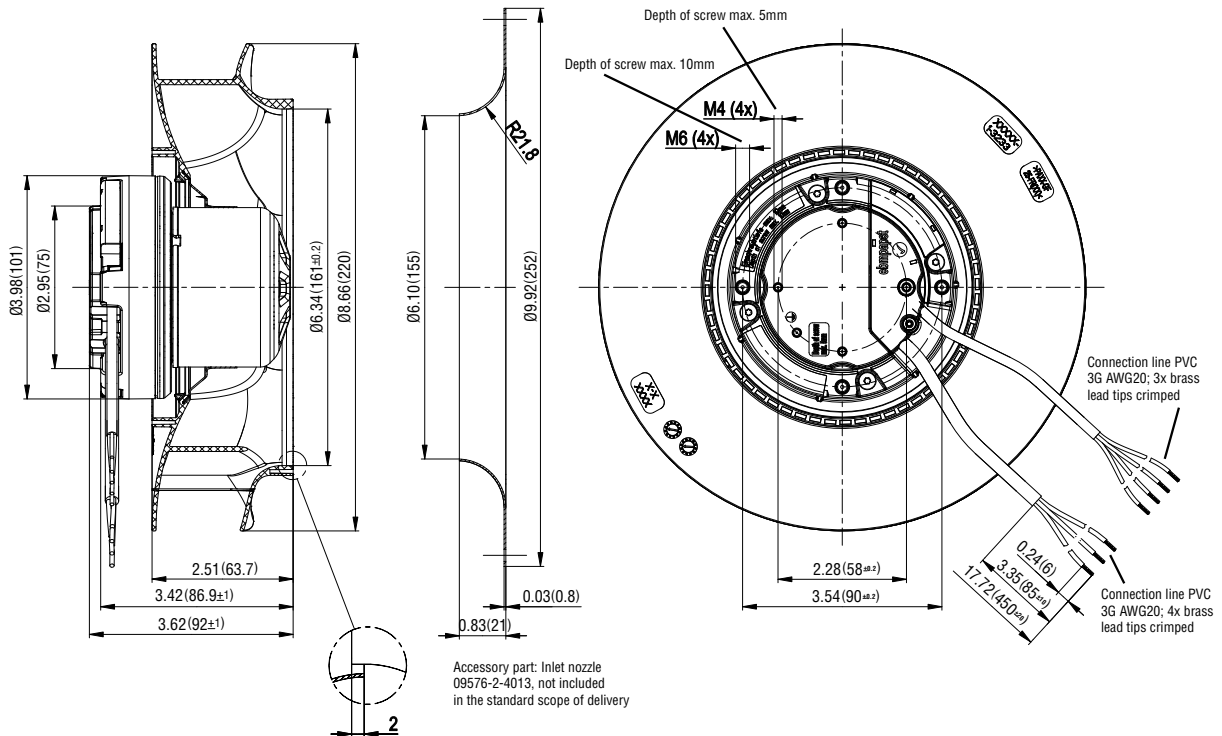

EC centrifugal fans - RadiCal®

Series R3G225 RE Ø225 mm



Highlights:

- Backward curved
- 7-blade impeller, single phase motor
- Output 10 VDC, max. 1.1 mA, Tach output, Control input 0-10 VDC / PWM
- Motor current limit, Soft start, Locked-rotor protection, Over temperature protected electronics / motor
- Mounting position: Any
- Condensate discharge holes: None, open rotor
- Ingress protection of IP54

Material: Fiberglass reinforced composite
Impeller: PA6

Direction of rotation: Clockwise, seen on rotor

Nominal Data	Air flow	Nominal voltage	Voltage range	Hertz	Ball bearings	Power input	Speed (1)	Temperature range (1)	Mass	Ingress Protection Rating	UL
	CFM	VAC	VAC			Watts	RPM	°C	g		
R3G225-RE19-04	753.4	115	100...130	50/60	Yes	170	2,870	-25...50	1,750	IP54	Yes
R3G225-RE07-03	765.2	230	200...240	50/60	Yes	170	2,860	-25...60	1,750	IP54	Yes

(1) Nominal data at maximum load.

R3G225-RE19-04 Curves

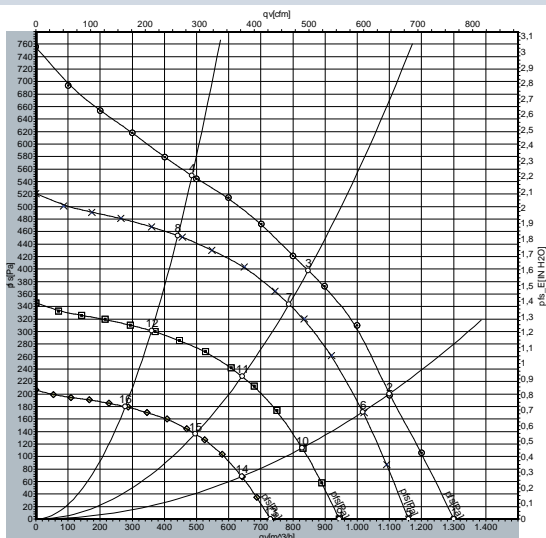

Measurement: LU-142355

Air performance measured as per: ISO 5801, Installation category A, without protection against accidental contact.

Suction-side noise levels: LwA as per ISO 13347, LPA measured at 1m distance to fan axis.

The values given are valid under the measuring conditions mentioned and may vary according to the actual installation situation.

With any deviation to the standard set-up, the specific values have to be checked and reviewed once installed or fitted.

For detailed information on the measuring set-up, please contact ebm-papst.

	n	Pe	I	LwA
	rpm	W	A (115V)	dB(A)
(A) 1	2985	153	1.99	78
(A) 2	2870	170	2.20	74
(A) 3	2895	162	2.09	68
(A) 4	2965	150	1.95	73
(A) 5	2500	90	1.17	75
(A) 6	2500	113	1.45	70
(A) 7	2500	104	1.34	66
(A) 8	2500	90	1.17	69
(A) 9	2000	46	0.60	69
(A) 10	2000	58	0.74	65
(A) 11	2000	53	0.69	61
(A) 12	2000	46	0.60	63
(A) 13	1500	19	0.25	63
(A) 14	1500	25	0.31	59
(A) 15	1500	23	0.29	55
(A) 16	1500	19	0.25	57

R3G225-RE07-03 Curves

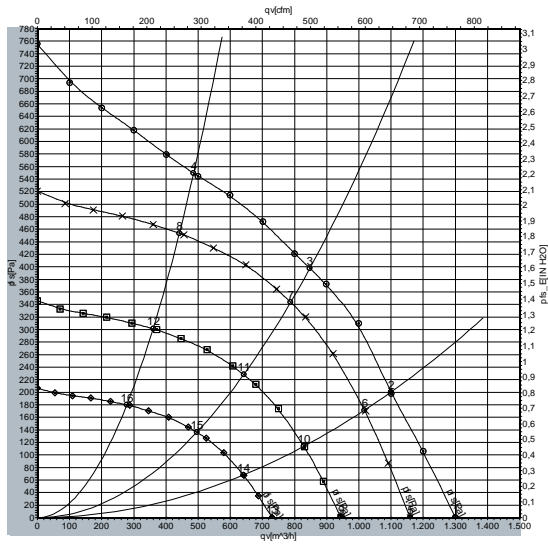

Measurement: LU-129100

Air performance measured as per: ISO 5801, Installation category A, without protection against accidental contact.

Suction-side noise levels: LwA as per ISO 13347, LpA measured at 1m distance to fan axis.

The values given are valid under the measuring conditions mentioned and may vary according to the actual installation situation.

With any deviation to the standard set-up, the specific values have to be checked and reviewed once installed or fitted.

For detailed information on the measuring set-up, please contact ebm-papst.

	n	Pe	I	LwA
	rpm	W	A (230V)	dB(A)
ⓑ 1	3030	151	1.25	78
ⓑ 2	2910	168	1.40	74
ⓑ 3	2860	170	1.40	68
ⓑ 4	2970	157	1.35	73
ⓑ 5	2700	107	0.89	76
ⓑ 6	2700	134	1.11	72
ⓑ 7	2700	135	1.15	67
ⓑ 8	2700	118	1.01	70
ⓑ 9	2200	58	0.48	70
ⓑ 10	2200	73	0.60	67
ⓑ 11	2200	73	0.62	62
ⓑ 12	2200	64	0.55	65
ⓑ 1E	1700	27	0.22	64
ⓑ 14	1700	33	0.28	61
ⓑ 15	1700	34	0.29	56
ⓑ 16	1700	29	0.25	59

R3G225-REXX-XX

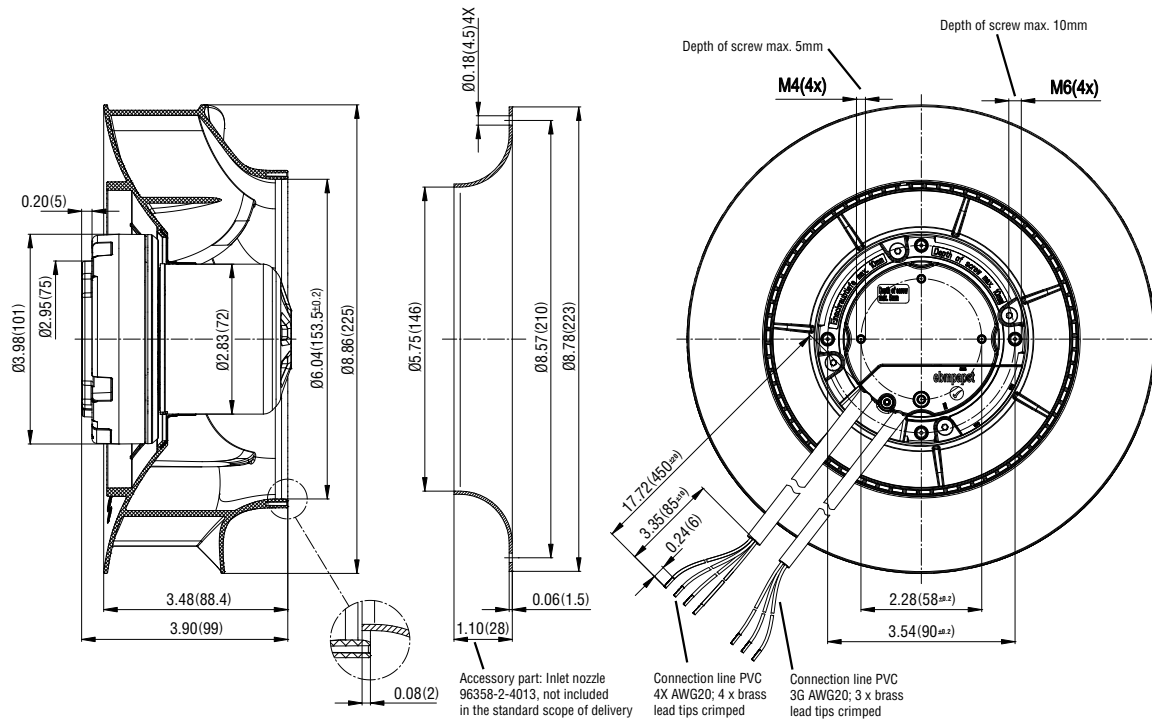

EC centrifugal fans - RadiCal®

Series R3G250 RE Ø250 mm



Highlights:

- Backward curved
- 7-blade impeller, single phase motor
- Output 10 VDC, max. 1.1 mA, Tach output, Control input 0-10 VDC / PWM
- Motor current limit, Soft start, Locked-rotor protection, Over temperature protected electronics / motor
- Mounting position: Any
- Condensate discharge holes: None, open rotor
- Ingress protection of IP54

Material: Fiberglass reinforced composite
Impeller: PA6

Direction of rotation: Clockwise, seen on rotor

Nominal Data	Air flow	Nominal voltage	Voltage range	Hertz	Ball bearings	Power input	Speed (1)	Temperature range (1)	Mass	Ingress Protection Rating	UL
	CFM	VAC	VAC			Watts	RPM	°C	g		
R3G250-RE21-08	829.9	115	100...130	50/60	Yes	160	2,520	-25...60	2,400	IP54	Yes
R3G250-RE07-07	842.2	230	200...240	50/60	Yes	170	2,510	-25...60	1,800	IP54	Yes

(1) Nominal data at operating point with maximum load.

R3G250-RE21-08 Curves

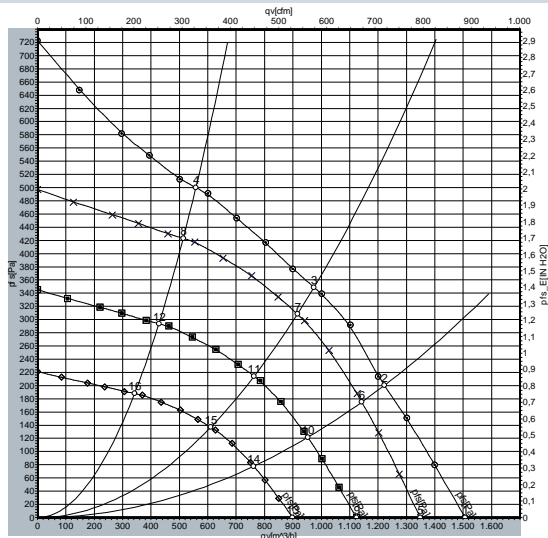

Measurement: LU-142364

Air performance measured as per: ISO 5801, Installation category A, without protection against accidental contact.

Suction-side noise levels: LwA as per ISO 13347, LPA measured at 1m distance to fan axis.

The values given are valid under the measuring conditions mentioned and may vary according to the actual installation situation.

With any deviation to the standard set-up, the specific values have to be checked and reviewed once installed or fitted.

For detailed information on the measuring set-up, please contact ebm-papst.

	n rpm	Pe W	I A (115V)	LwA dB(A)
(A) 1	2615	135	1.76	75
(A) 2	2535	155	2.01	71
(A) 3	2520	160	2.10	67
(A) 4	2580	145	1.90	73
(A) 5	2400	104	1.36	73
(A) 6	2400	131	1.70	69
(A) 7	2400	138	1.79	66
(A) 8	2400	117	1.53	70
(A) 9	2000	60	0.79	69
(A) 10	2000	76	0.99	65
(A) 11	2000	80	1.03	62
(A) 12	2000	68	0.89	66
(A) 13	1600	31	0.40	63
(A) 14	1600	39	0.50	59
(A) 15	1600	41	0.53	56
(A) 16	1600	35	0.45	60

R3G250-RE07-07 Curves

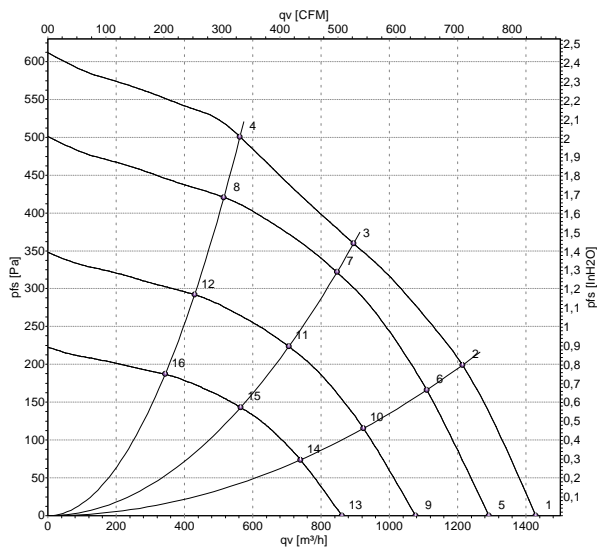

Measurement: LU-154717

Air performance measured as per: ISO 5801, Installation category A, without protection against accidental contact.

Suction-side noise levels: LwA as per ISO 13347, LPA measured at 1m distance to fan axis.

The values given are valid under the measuring conditions mentioned and may vary according to the actual installation situation.

With any deviation to the standard set-up, the specific values have to be checked and reviewed once installed or fitted.

For detailed information on the measuring set-up, please contact ebm-papst.

	n	Pe	I	LwA
	rpm	W	A (230V)	dB(A)
ⓑ 1	2655	143	1.18	76
ⓑ 2	2630	170	1.40	72
ⓑ 3	2510	170	1.40	67
ⓑ 4	2620	168	1.39	73
ⓑ 5	2400	105	0.87	73
ⓑ 6	2400	129	1.07	69
ⓑ 7	2400	144	1.19	66
ⓑ 8	2400	129	1.07	70
ⓑ 9	2000	61	0.51	69
ⓑ 10	2000	75	0.62	65
ⓑ 11	2000	83	0.69	62
ⓑ 12	2000	75	0.62	66
ⓑ 13	1600	31	0.26	63
ⓑ 14	1600	38	0.32	59
ⓑ 15	1600	43	0.35	56
ⓑ 16	1600	38	0.32	60

R3G250-REXX-XX

