

## EN3<sup>®</sup> SERIES WEATHERTIGHT CONNECTORS

NEW PRODUCT BULLETIN 602

# SWITCHCRAFT<sup>®</sup>

A H E I C O C O M P A N Y



Please visit [www.switchcraft.com](http://www.switchcraft.com) for the most up-to-date product specifications. Made in USA.

# EN3® SERIES WEATHERTIGHT CONNECTORS

NEW PRODUCT BULLETIN 602



## FEATURES & BENEFITS

- Sealed to IP68 NEMA 250 (6P)
- Grommet & o-ring free design
- Available in ribbed or winged coupling ring
- Cable, panel & cable to cable options
- Gold plated contacts standard
- Solder, crimp & PC contact options
- Straight & right angle PC contact panel connectors

## APPLICATIONS

- Any sealed data transmission
- Military or industrial GPS location devices
- Instrumentation
- Medical data carts
- Marine Applications
- Transportation
- General industrial electronic applications



Please visit [www.switchcraft.com](http://www.switchcraft.com) for the most up-to-date product specifications. Made in USA.

# EN3<sup>®</sup> SERIES WEATHERTIGHT CONNECTORS

NEW PRODUCT BULLETIN 602

## SPECIFICATIONS

### MECHANICAL SPECIFICATIONS

Life:	Minimum 600 insertion / withdrawal cycles
Vibration:	Mil-Std 202 Method 201
Shock:	Mil-Std 202 Method 213B, condition K
Hex Nut Torque:	All series hex nut to withstand 8-10 in-lb tightening torque.
Coupling Locking Style	Bayonet with ribbed coupling nut (winged coupling nut optional)
Back Shell Style:	Boot

### ELECTRICAL SPECIFICATIONS

Voltage Rating:	250 V AC/DC
Current Rating:	13.0 A – 2 or 3 #16 contacts accepts 16 through 18 AWG 7.5 A – 2 through 6 #20 contacts accepts 20 through 22 AWG 6.5 A – 7 or 8 #20 contacts accepts 20 through 22 AWG 3 A – 9 through 18 #26 contacts accepts 26 through 28 AWG
Insulation Resistance:	100 MΩ min
Contact Resistance:	20 mΩ max

### ENVIRONMENTAL SPECIFICATIONS

Operating Temperature Rating:	-40°C to +65°C (-40°F to +149°F)
Moisture Resistance:	Mil-Std 202 Method 106F
Insulation Resistance:	Mil-Std 202 Method 302 condition B
Thermal Shock:	Mil-Std 202 Method 107G
Salt Atmosphere (Corrosion):	Mil-Std 202 Method 101D condition B
Weathertight:	IEC 60529 IP16/IP18 IEC 60529 IP66/IP68 IEC 60529 IP68 NEMA 250 (6P) CFR 46 Part 110.20

### MATERIAL SPECIFICATIONS

Panel connector shells & locking disk:	Thermoplastic UL94V-0
Connector shell interior:	Elastomeric, Black UL 94HB
Contacts:	Copper Alloy, Gold over Nickel Plate

### MOLDED CABLE ASSEMBLIES

Weathertight:	IEC 60529 IP66/IP68 IEC 60529 IP68 NEMA 250 (6P) CFR 46 Part 110.20
---------------	--

### CERTIFICATIONS

UL File E319753 ; 2-8 pin cord, in-line and panel only



Please visit [www.switchcraft.com](http://www.switchcraft.com) for the most up-to-date product specifications. Made in USA.

# EN3® SERIES WEATHERTIGHT CONNECTORS

NEW PRODUCT BULLETIN 602

## CORD CONNECTORS

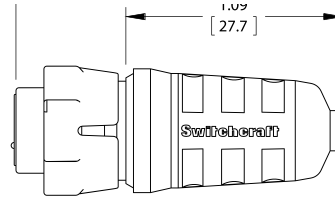
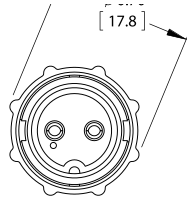

EN3 SERIES 2-18 POSITION  
STANDARD  
CABLE CLAMP & BOOT

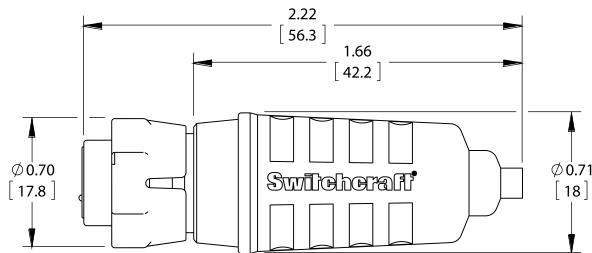

OPTION "L"  
EN3 SERIES 2-18 POSITION  
LARGE CABLE CLAMP & BOOT

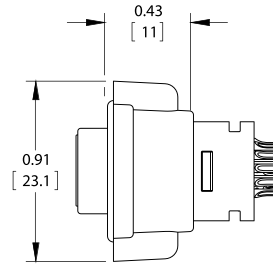

OPTION "W"  
EN3 SERIES 2-18 POSITION  
WINGED COUPLING RING

## CABLE TO CABLE CONNECTORS

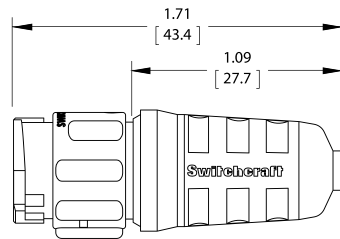
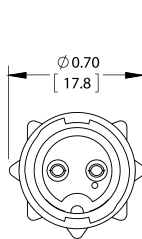

EN3 SERIES 2-18 POSITION  
STANDARD  
CABLE CLAMP & BOOT  
INLINE CONNECTOR

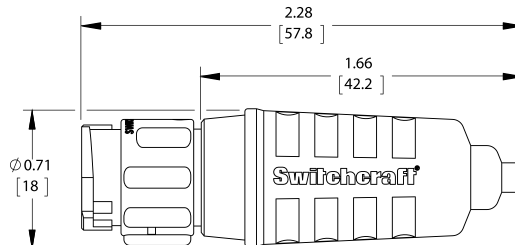

OPTION "L"  
EN3 SERIES 2-18 POSITION  
LARGE CABLE CLAMP & BOOT  
INLINE CONNECTOR

## EN3® RIGHT ANGLE 2-8 POSITION MOLDED CONNECTORS

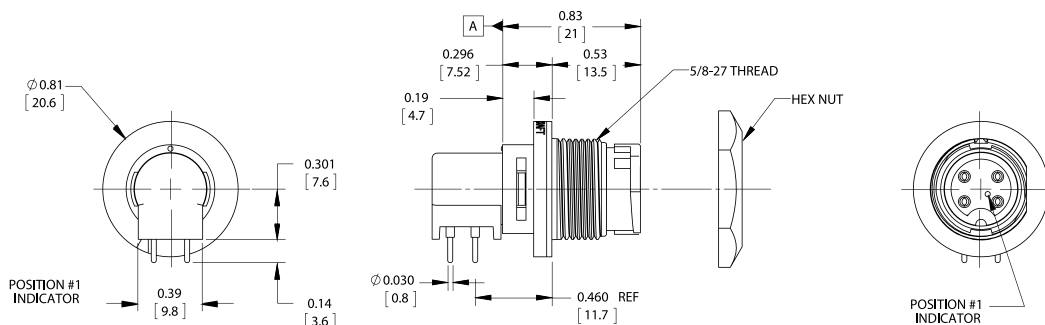

Please visit [www.switchcraft.com](http://www.switchcraft.com) for the most up-to-date product specifications. Made in USA.

# EN3® SERIES WEATHERTIGHT CONNECTORS

## NEW PRODUCT BULLETIN 602

### PANEL CONNECTORS

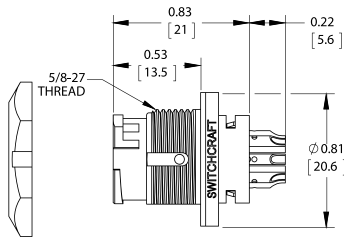

EN3 SERIES 2-8 POSITION  
STANDARD SOLDER CUP  
ALL POSITIONS FACE RADICALLY OUTWARD  
EN3P8MX SHOWN

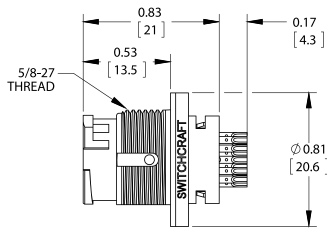

EN3 SERIES 9-18 POSITION  
STANDARD SOLDER CUP  
ALL POSITIONS FACE UPWARD  
EN3P18M26X SHOWN

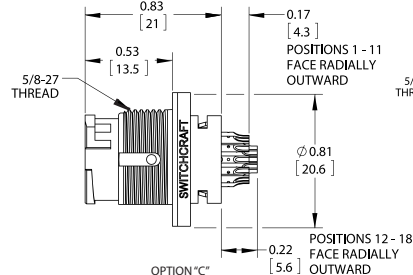

OPTION "C"  
EN3 SERIES 2-8 POSITION  
CRIMP TERMINALS  
EN3P2M6CX SHOWN

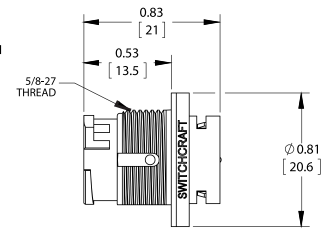

OPTION "S"  
EN3 SERIES 9-18 POSITION ONLY  
STANDARD SOLDER CUP  
EN3P18M26SX SHOWN

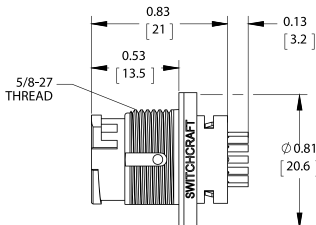

OPTION "C"  
EN3 SERIES 9-18 POSITION  
CRIMP TERMINALS  
EN3P2M26CX SHOWN

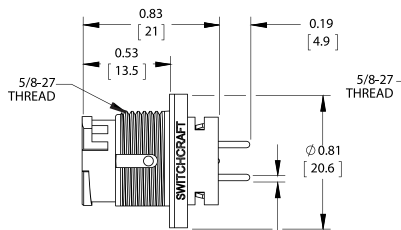

OPTION "P"  
EN3 SERIES 2-8 POSITION  
PC TERMINALS  
EN3P2MPX SHOWN

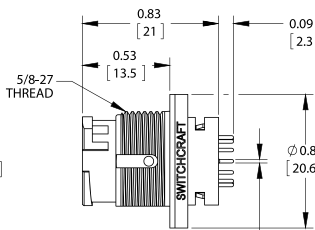

OPTION "P"  
EN3 SERIES 9-18 POSITION  
PC TERMINALS  
EN3P9M26PX SHOWN

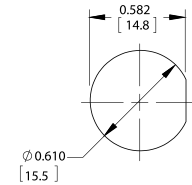

RECOMMENDED PANEL CUT-OUT  
0.188 MAX PANEL THICKNESS ± 0.003 [0.08MM]  
MOUNTING NUT  
8-10 INCH-LBS MAX TORQUE

### RIGHT ANGLE PC BOARDS 2-18 CONTACT PANEL CONNECTORS

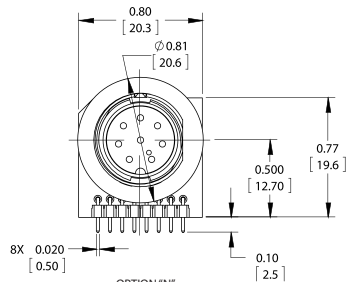

OPTION "N"  
EN3 SERIES 2-8 POSITION  
NARROW PCB  
EN3P8MRAPCBN SHOWN  
(NOT AVAILABLE IN FEMALE 7 & 8 POSITION)

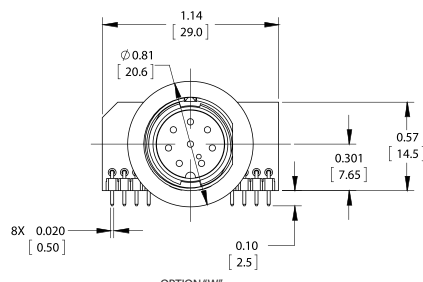

OPTION "W"  
EN3 SERIES 2-8 POSITION  
WIDE PCB  
EN3P8MRAPCBW SHOWN  
(NOT AVAILABLE IN FEMALE 7 & 8 POSITION)

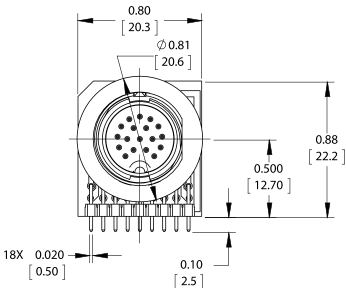
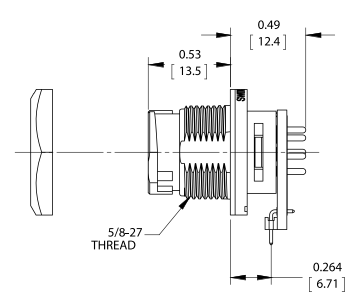

OPTION "N"  
EN3 SERIES 9-18 POSITION  
NARROW PCB  
EN3P18MRAPCBN SHOWN

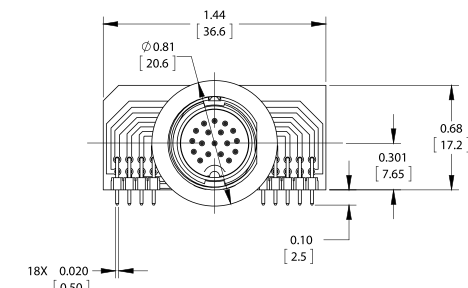

OPTION "W"  
EN3 SERIES 9-18 POSITION  
WIDE PCB  
EN3P18MRAPCBW SHOWN

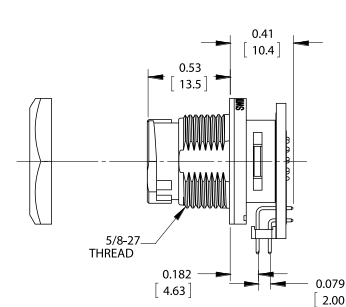

Please visit [www.switchcraft.com](http://www.switchcraft.com) for the most up-to-date product specifications. Made in USA.

# EN3® SERIES WEATHERTIGHT CONNECTORS

NEW PRODUCT BULLETIN 602

## EN3® ORDERING CODE

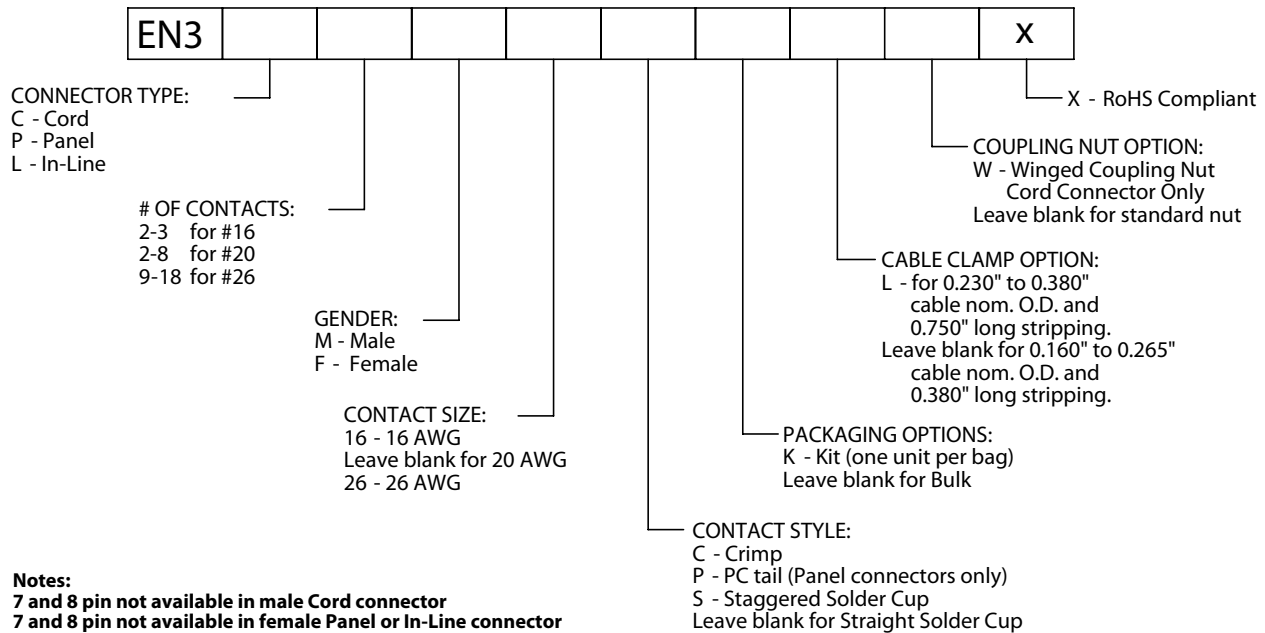

## EN3® RIGHT ANGLE PC BOARD MOUNT 2-18 CONTACT ORDERING CODE

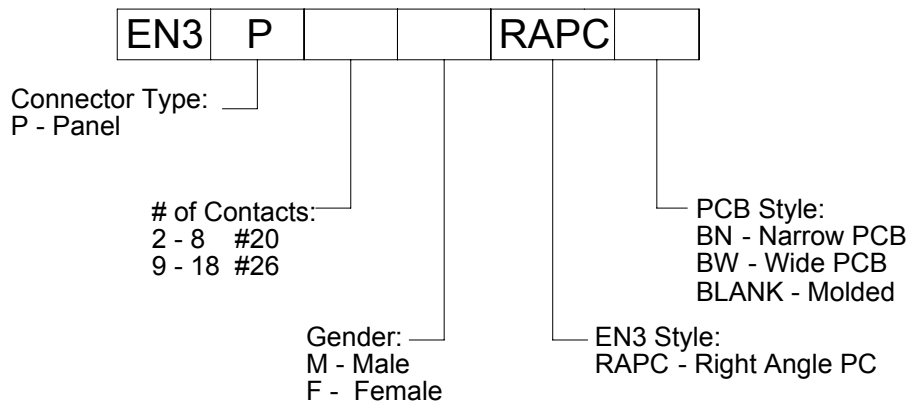

## EN3® SERIES ACCESSORIES

<b>EN3 BOOT</b>	EN3 SERIES, REGULAR BOOT FOR CABLE DIAMETERS 0.160"-0.265"
<b>EN3 BOOTL</b>	EN3 SERIES, LARGE BOOT FOR CABLE DIAMETERS 0.230"-0.380"
<b>EN3CAP</b>	EN3 HARSH ENVIRONMENT PANEL OR CABLE END CAP RATED TO IP68, RUBBER LANYARD STYLE
<b>EN3CAPC</b>	CORD PLUG CAP FOR EN3 SERIES
<b>EN3CLAMPX</b>	EN3 HARSH ENVIRONMENT CABLE CLAMP
<b>EN3IPCAPX</b>	EN3 SERIES, IP68 RATED PANEL OR INLINE CAP WITH LOCK RING
<b>EN3NUT</b>	EN3 HARSH ENVIRONMENT HARDWARE-NUT
<b>EN3PQCA</b>	EN3 PANEL ADAPTOR, FOR USE WITH EN3 QUICK CONNECT/ DISCONNECT CABLE ASSEMBLIES



Please visit [www.switchcraft.com](http://www.switchcraft.com) for the most up-to-date product specifications. Made in USA.